



**MST**  
MAX SPEED TECHNOLOGY

# FXX-D RTR

1/10 SCALE RC RWD HIGH PERFORMANCE DRIFT CAR

## EXPLODED MANUAL

ON ROAD USE ONLY  
FULL BALL BEARINGS

WHEELBASE : STANDARD 257mm (adjustable)  
WIDTH : STANDARD 190mm (adjustable)  
GEAR RATIO : 2.12 (36T/17T)  
CASTER : 8 degrees variableness  
CAMBER : 0 to -12 degrees

[www.rc-mst.com](http://www.rc-mst.com)

\*SPECIFICATION ARE SUBJECT TO CHANGE WITHOUT NOTICE

# FXX-D RTR

1/10 SCALE RC RWD HIGH PERFORMANCE DRIFT CAR



Appreciate for your choice of FXX-D RTR! You will be impressed with its performance and beauty. Please prepare additional parts as car battery, transmitter battery, and charger. Please follow the process for assemble and setting of parts package. If you have doubt or need assistance, please contact the purchased shop or hobby shop for help, many thanks!

首先感謝你購入 FXX-D RTR 這項產品，您將擁有一部兼具性能與美型的甩尾車。在首次操作前，有以下幾項須要另行購置的物件：車用電池、遙控器用電池、充電器。備妥上述物件後，請進行零件包安裝與設定。如需其他協助，請向原購買店家，或遙控模型店詢問！謝謝！

PLEASE FOLLOW BELOW OPERATIONS BEFORE ASSEMBLING THE PARTS PACKAGE. 請於安裝零件包之前執行以下操作



- |                                     |                 |
|-------------------------------------|-----------------|
| 1 Install transmitter batteries.    | 1 安裝遙控器電池       |
| 2 Loosen receiver antenna.          | 2 鬆開接收機天線       |
| 3 Connector ESC and battery.        | 3 聯結車用電池與電子變速器  |
| 4 Switch on the transmitter.        | 4 打開遙控器電源       |
| 5 Trims the transmitter in neutral. | 5 調整遙控器各微調器至中立點 |
| 6 Switch on the ESC.                | 6 打開電子變速器電源     |
| 7 Completed.                        | 7 完成            |

※ Please play this product in opening safe area. 請於空曠或安全無虞的場所，使用本項產品。

※ FXX-D RTR electronics (Transceiver set/ESC/Gyro) are set by factory and can be directly used after attaching battery. Please refer to instructions for adjusting. FXX-D RTR 之電子設備 (遙控器組/電子變速器/陀螺儀) 已經過原廠設定，玩家可於安裝電池後立即使用；如需依個人習慣調整時，再翻閱說明書。

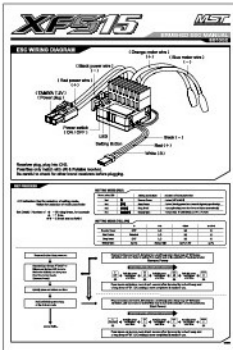

※ Please refer to transmitter & receiver performance instructions. 遙控器&接收機功能說明請參閱詳細說明書。

※ Please refer to ESC performance instructions. 電子變速器功能說明請參閱詳細說明書。

※ Please refer to LSD2.0-S CAR GYRO performance instructions. 陀螺儀功能說明請參閱詳細說明書。

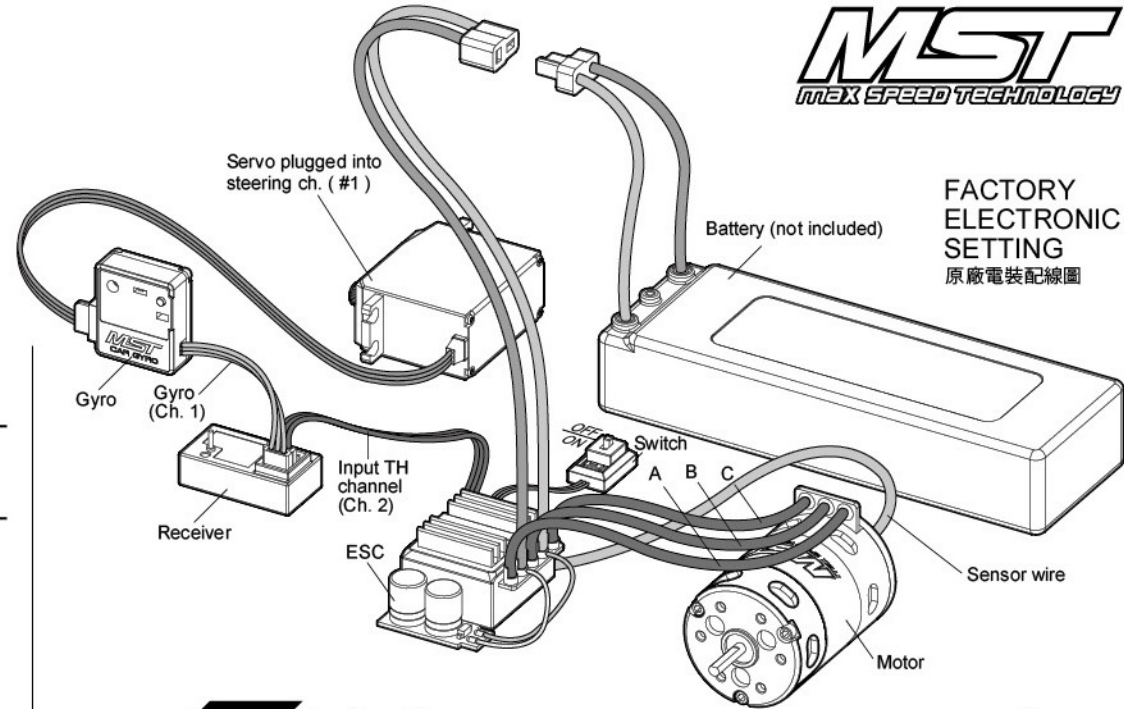

FACTORY ELECTRONIC SETTING 原廠電裝配線圖

## STEP 1 Pasting Sponge 貼上吸震泡棉

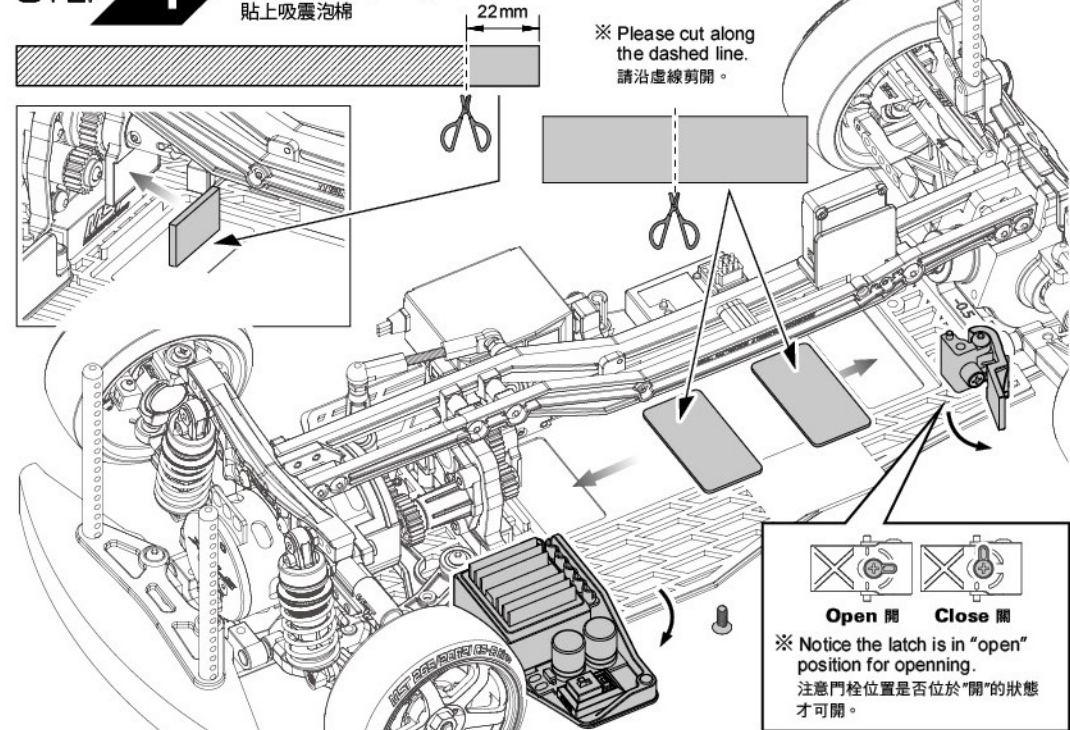

## STEP 2 Attaching Battery 安裝電池

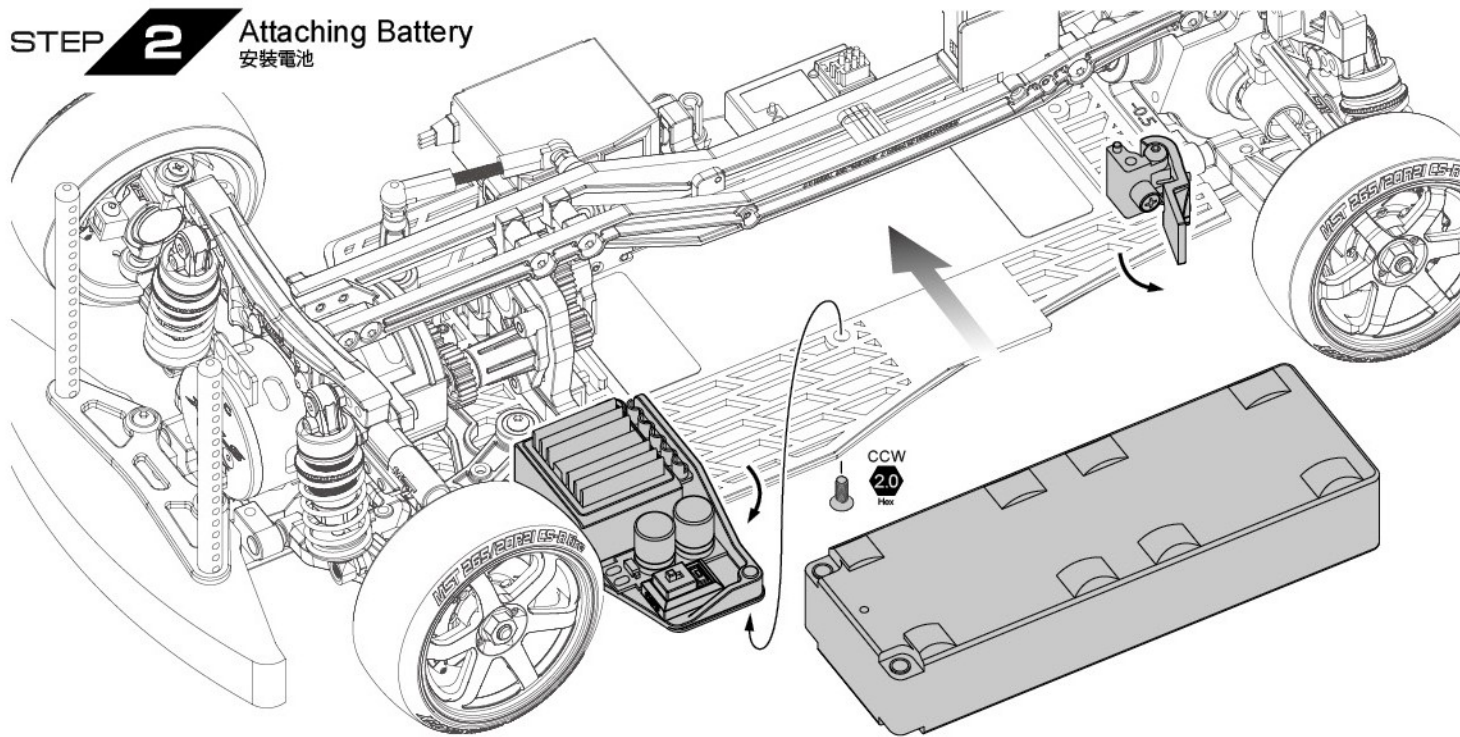

※ The assembly and conservation method may be different by specification of battery.

電池的安裝方式會因為廠牌規格而有些微差異，電池的使用方式與保存方式，也會因電池的種類而有所不同。

※ Recommended battery measurement L140×W48×H25.4mm (not exceed)  
建議安裝長140×寬48×高25.4mm尺寸以內的電池。

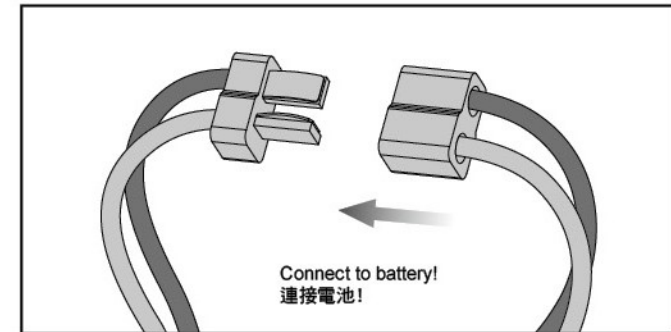

※ Please play in safe place after all setting finish.  
Before playing, please switch on transmitter then on the car.  
Please switch off reversely.  
安裝設定完成後，請於安全場所使用本產品！  
使用前請先開啟遙控器電源後再開啟車體電源！  
使用後請反向操作關閉！

## STEP 3 Attaching Body Mount 車殼浮動架安裝



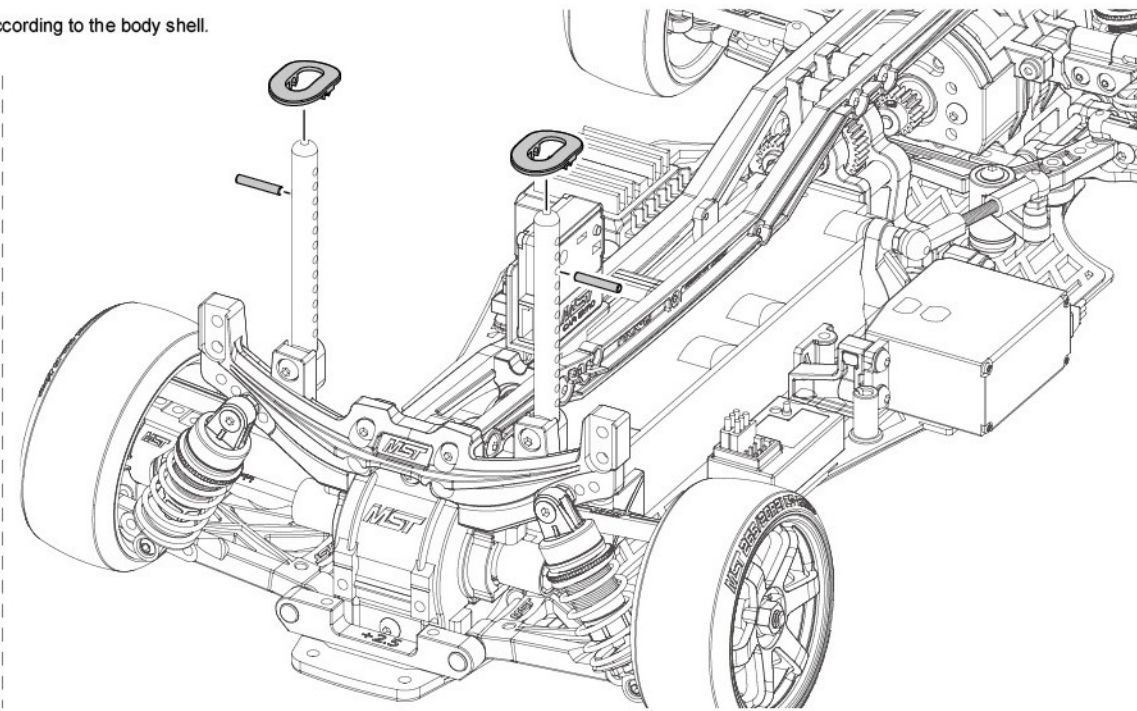
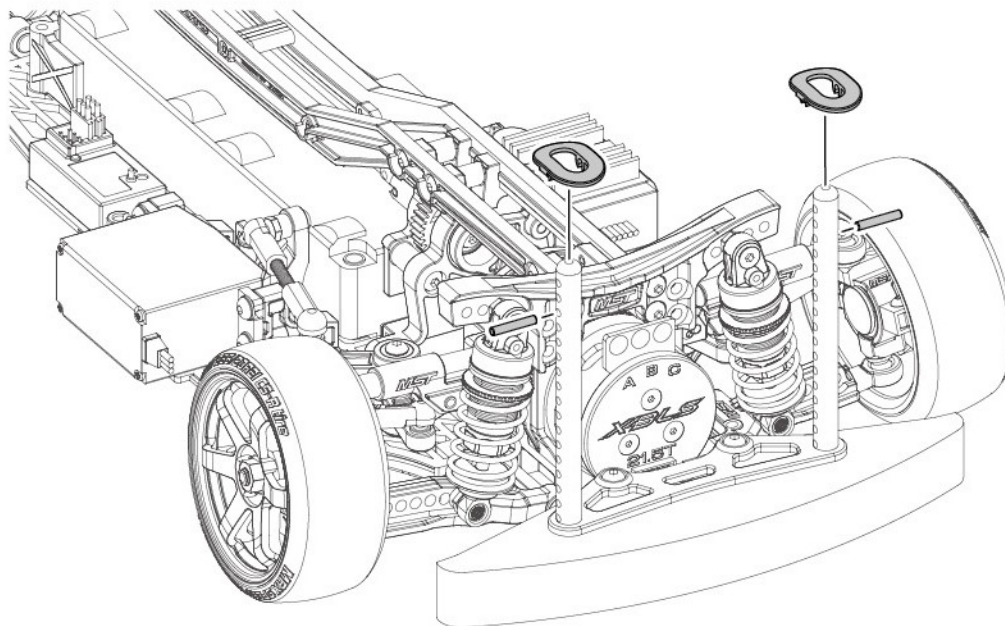



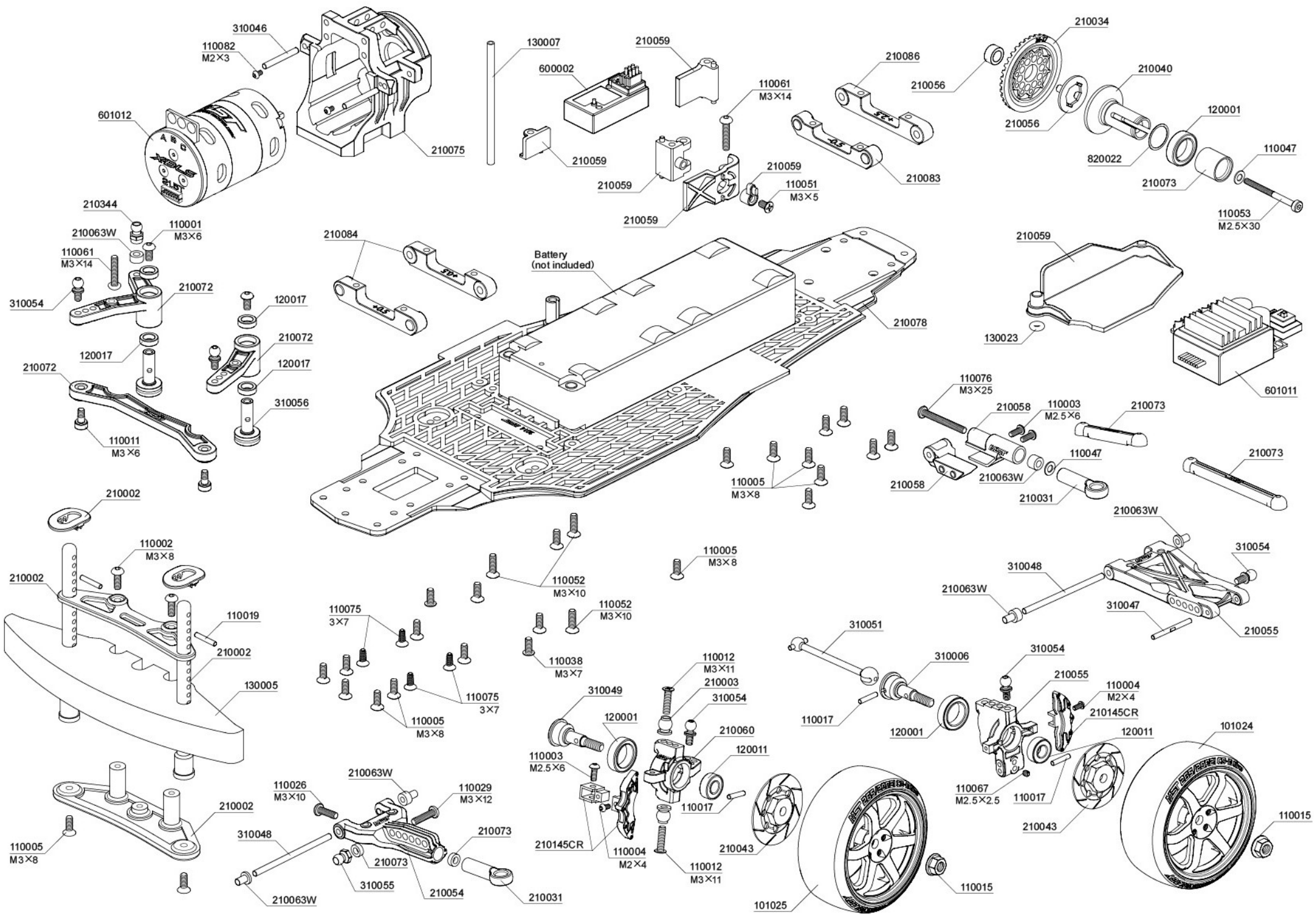





























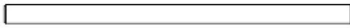













※ Adjust the body mount highness according to the body shell.  
依照車殼調整浮動架高度。











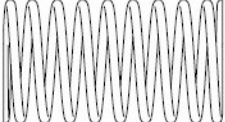
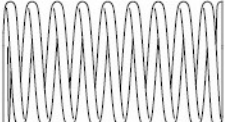
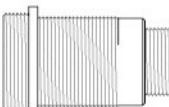

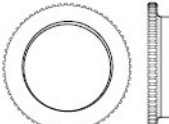

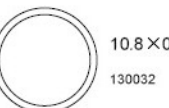
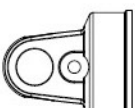

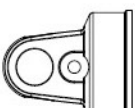
# PARTS

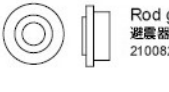
 M2×3 Screw ×2 圓頭螺絲 110082	 M3×5 Screw ×1 十字高頭螺絲 110051	 1.5×7.8 Shaft ×1 插銷 110059	 4×6×0.1 Spacer ×1 墊片 820015
 M2×4 Screw ×4 圓頭螺絲 110004	 M3×7 Screw ×2 十字高頭螺絲 110038	 2×9.8 Shaft ×6 插銷 110017	 4×6×0.3 Spacer ×1 墊片 820017
 M2×5 Screw ×4 圓頭螺絲 110050	 M3×11 Screw ×4 十字高頭螺絲 110012	 2×9.8 Shaft ×2 插銷(剖槽) 110046	 3×6×0.5 Spacer ×10 墊片 110047
 M2×6 Screw ×2 圓頭螺絲 110044	 M2.5×2.5 Screw ×3 止付螺絲 110067	 2×11.8 Shaft ×5 插銷 110019	 3×8×0.5 Spacer ×1 墊片 110048
 M2.5×6 Screw ×6 圓頭螺絲 110003	 M3×3 Screw ×3 止付螺絲 110035	 2.5×20 Arm shaft ×2 擺臂插銷 310046	 10×12×0.1 Spacer ×1 墊片 820022
 M3×5 Screw ×2 圓頭螺絲 110049	 M3×25 Screw ×1 止付螺絲 110008	 2×22 Shaft ×2 擺臂插銷(剖溝) 310047	 10×12×0.3 Spacer ×1 墊片 820024
 M3×6 Screw ×13 圓頭螺絲 110001	 M3×5 Screw ×4 沉頭螺絲 110041	 2.5×46 Arm shaft ×4 擺臂插銷 310048	 4.8×4.5 Copper ball connector ×10 銅製球頭螺絲 310054
 M2×8 Screw ×2 圓頭螺絲 110063	 M3×8 Screw ×24 沉頭螺絲 110005	 M4 Wheel nut ×4 輪框螺帽 110015	 4.8 Copper hex ball ×7 銅製外六角球頭 310055
 M3×8 Screw ×14 圓頭螺絲 110002	 M3×10 Screw ×3 沉頭螺絲 110052	 3.0 E-Clip ×1 E型扣 110070	 4.8 Ball connector L ×1 外六角球頭(長) 210344
 M3×10 Screw ×10 圓頭螺絲 110026	 M3×6 Screw ×2 有頭螺絲(半牙) 110011	 Gear C shaft ×1 終齒軸 210347	 5.8 Ball connector ×4 球頭 210003
 M3×12 Screw ×3 圓頭螺絲 110029	 M2.5×30 Screw ×1 有頭螺絲(半牙) 110053	 Drive gear shaft ×1 驅動齒軸 310052	 G9 G-Clip ×2 G型扣 110069
 M3×14 Screw ×2 圓頭螺絲 110061	 3×7 Screw ×4 自攻沉頭螺絲 110075		
 M3×25 Screw ×2 圓頭螺絲 110076	 3×8 Screw ×4 自攻圓頭螺絲 110074		
 3×6 Screw ×4 自攻圓頭螺絲 110022	 2.6×10 Screw ×1 自攻圓頭螺絲 110025		

 Coil spring 29mm (silver) ×2 避震彈簧 29mm (銀) 210273-1	 Soft coil spring 29mm (red) ×2 軟避震彈簧 29mm (紅) 210351-3
 Damper cylinder ×4 避震筒身 210071	 Piston rod ×4 避震軸心 310008
 Spring retainer ×4 避震器調整環 (310053)	 Piston ×4 避震活塞 210082
 10.8×0.9 O-ring ×4 O環 130032	
 P3 Damper O-ring (red) ×4 避震器O環(紅) 130001	 E-clip ×8 E形扣 110013
 Cylinder cap ×4 避震器上蓋 210057	 Oil seal ×4 避震器氣室 130004
 Rod guide cap ×4 避震器下蓋 210057	 Rod guide ×4 避震器下蓋墊片 210082
 Damper retainer ×4 避震器彈簧座 820079	 Damper retainer ×4 避震器拉桿 820079

# PARTS

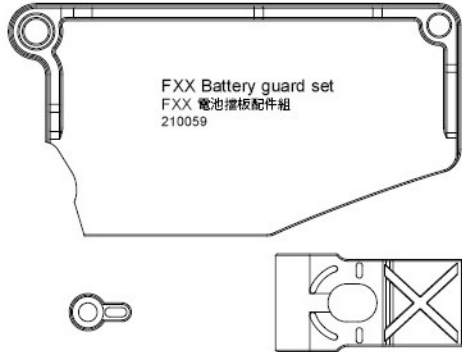

FXX Battery guard set  
FXX 電池擋板配件組  
210059

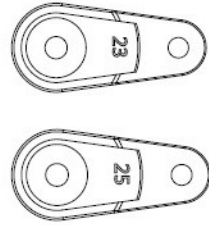

Servo horn set (25T/23T) × 1  
伺服機舵片組 (25T/23T)  
210032

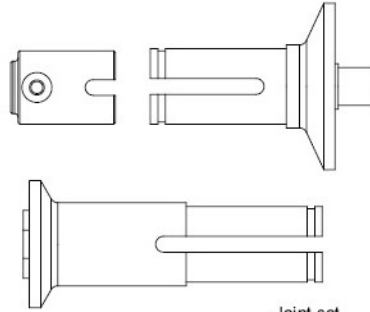

Joint set  
接杯組  
210040

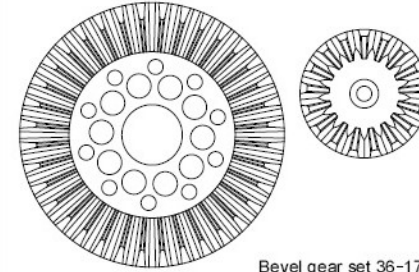

Bevel gear set 36-17  
傘齒組 36-17  
210034

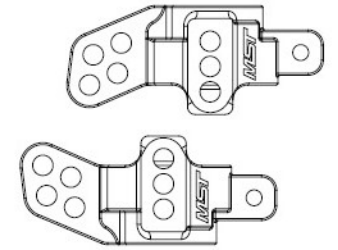

KPI Upright set  
KPI 輪座組  
210060

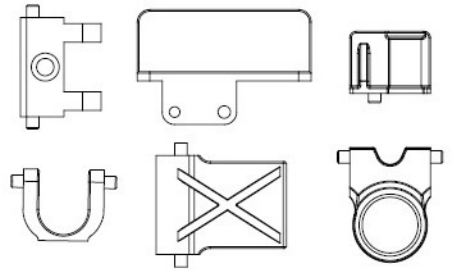

Lower arm mount +2.5 × 1  
下擺臂座組 +2.5  
210086

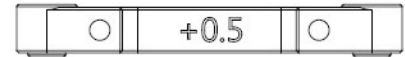

Lower arm mount +0.5 × 2  
下擺臂座組 +0.5  
210084



Lower arm mount -0.5 × 1  
下擺臂座組 -0.5  
210083



Shaft bush & spacer set (white)  
襯套墊片組 (白)  
210063W



4×8×3 ball bearing × 2  
培林  
120013



5×10×4 ball bearing × 3  
培林  
120002

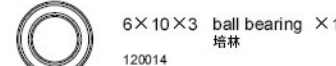

6×10×3 ball bearing × 1  
培林  
120014



5×11×4 ball bearing × 4  
培林  
120011

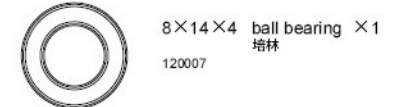

8×14×4 ball bearing × 1  
培林  
120007



10×15 ball bearing × 6  
培林  
120001

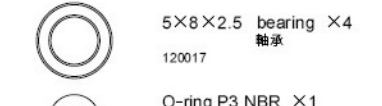

5×8×2.5 bearing × 4  
軸承  
120017

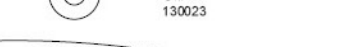

O-ring P3 NBR × 1  
O形環  
130023

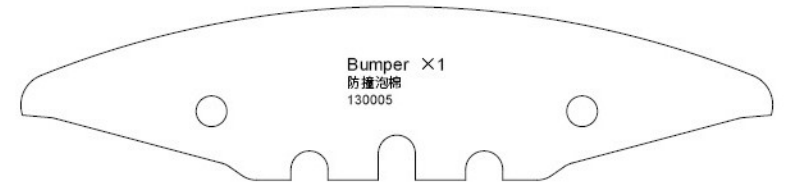

Bumper × 1  
防撞泡棉  
130005

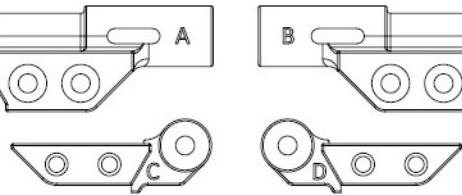

HT Upper arm  
HT 上擺臂  
210058

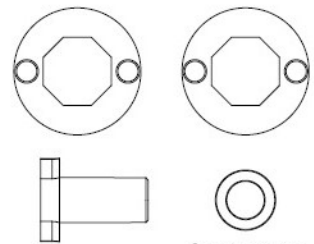

Spool parts set  
直軸配件組  
210056

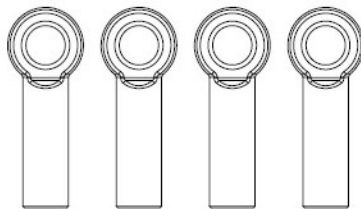

5.8×26 Reinforced adjuster set  
強化拉桿頭組  
210031

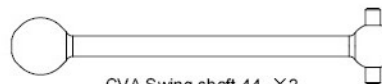

CVA Swing shaft 44 × 2  
CVA 傳動軸 44  
310051

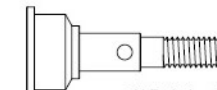

2WD Axle × 2  
二驅輪軸  
310049

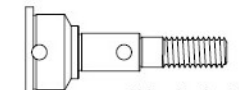

Wheel axle × 2  
萬向接杯  
310006



FXX Alum. rear driven shaft set  
FXX 鋁合金雙節後軸組  
(210335)

# PARTS



FXX Steering turnbuckle set ×2  
FXX 轉向拉桿組  
210073

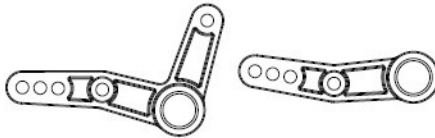

FXX Steering arm set  
FXX 轉向搖臂組  
210072

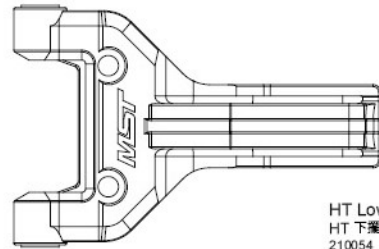

HT Lower arm ×2  
HT 下擺臂  
210054

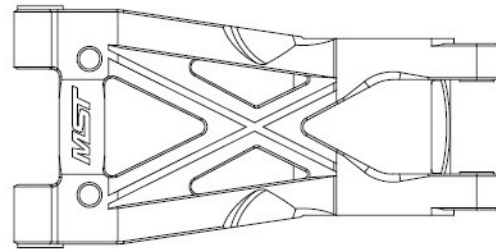

HT Rear lower arm & wheel hub ×2  
HT 後下擺臂&輪座  
210055

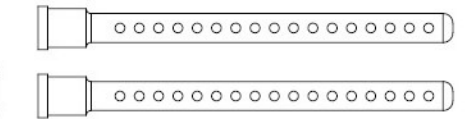
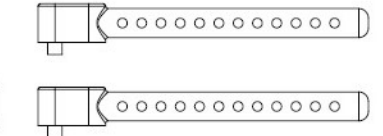
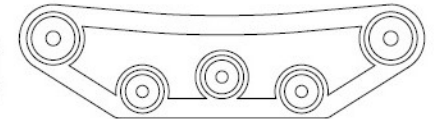
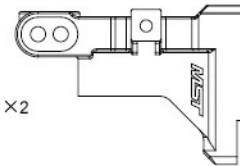

C PARTS - bumper set  
C PARTS - 防撞板組  
210002

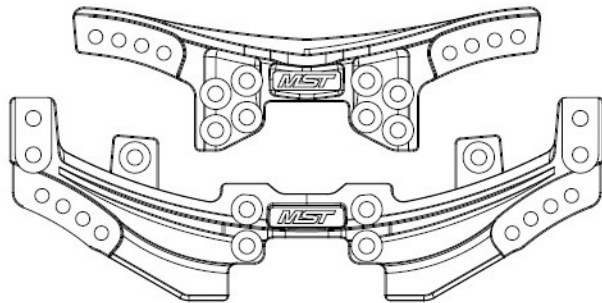

FXX FSX F&R damper stay  
FXX FSX 前後避震架  
230013



Brake calipers  
煞車卡鉗  
210145CR

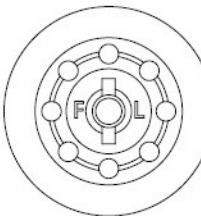
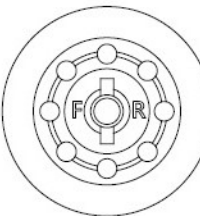
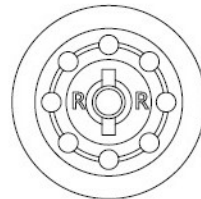
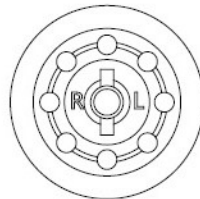

Wheel hubs w/disc shape  
碟型六角輪座組  
210043

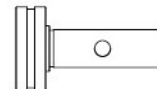

Steering arm post ×2  
轉向搖臂支柱  
210056

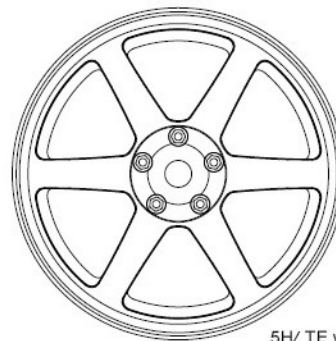

5H/ TE wheel  
5H/ TE 輪框  
(230011) / (230012)



**FRONT**

CS-R tire (medium)  
CS-R 甩尾胎 (中)



**REAR**

CS-R tire (soft)  
CS-R 甩尾胎 (軟)

101024	CS-R tire (soft) (4)	CS-R甩尾胎 (軟) (4)
101025	CS-R tire (medium) (4)	CS-R甩尾胎 (中) (4)
101026	CS-R tire (hard) (4)	CS-R甩尾胎 (硬) (4)
101027	CS-R tire (hardest) (4)	CS-R甩尾胎 (超硬) (4)
101028	CS-R tire (harder) (4)	CS-R甩尾胎 (高硬) (4)
101029	CS-R tire (HP) (4)	CS-R甩尾胎 (HP) (4)
101030	CS-R甩尾胎 (for carpet) (4)	CS-R甩尾胎 (地毯用) (4)



# PARTS

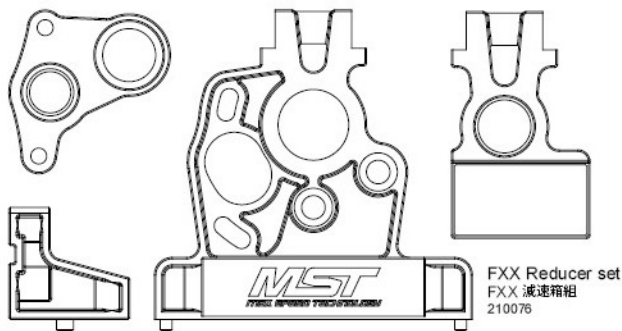

FXX Reducer set  
FXX 減速箱組  
210076

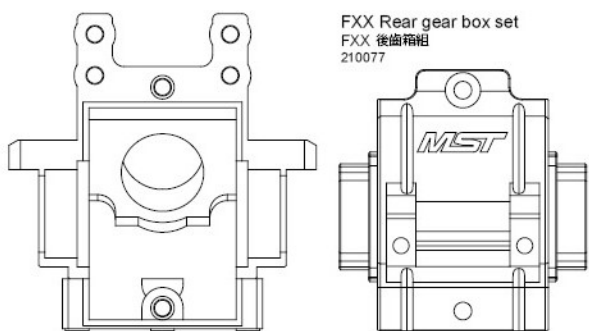

FXX Rear gear box set  
FXX 後齒箱組  
210077



Double sided tape  
海棉雙面膠  
130006

20×80×1 Sponge  
吸震泡棉  
130034

Inner sponge  
吸震泡棉  
130017

Antenna pipe  
天線管  
130007



MST Balancing weights 30g  
MST 配重塊 30g  
820088

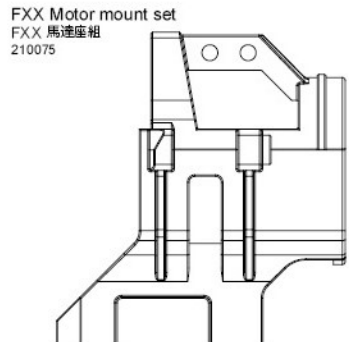

FXX Motor mount set  
FXX 馬達座組  
210075



LSD 2.0 S Gyro  
LSD 2.0 S 陀螺儀  
841003

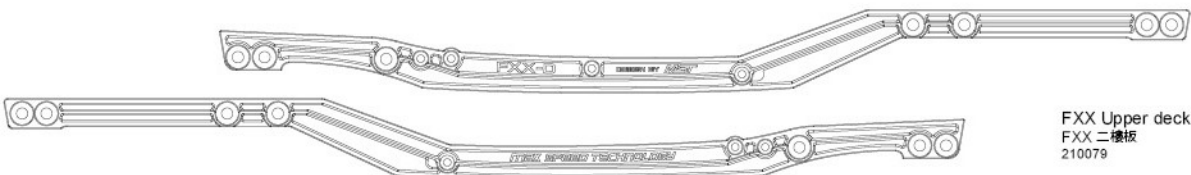

FXX Upper deck  
FXX 二樓板  
210079

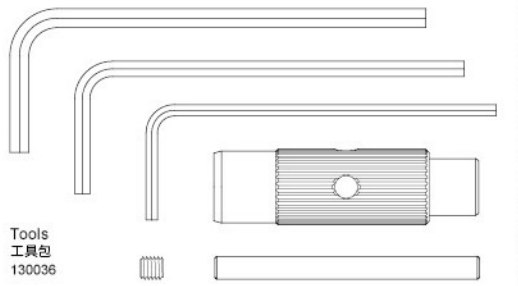

Tools  
工具包  
130036

0.05" L Wrench  
L 扳手  
110067

5.5 X4 Wrench  
扳手

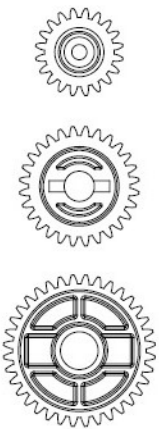
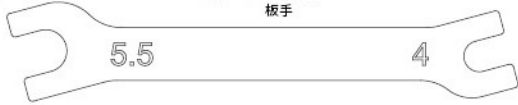

FXX Reduction gear set  
FXX 減速齒組  
210080

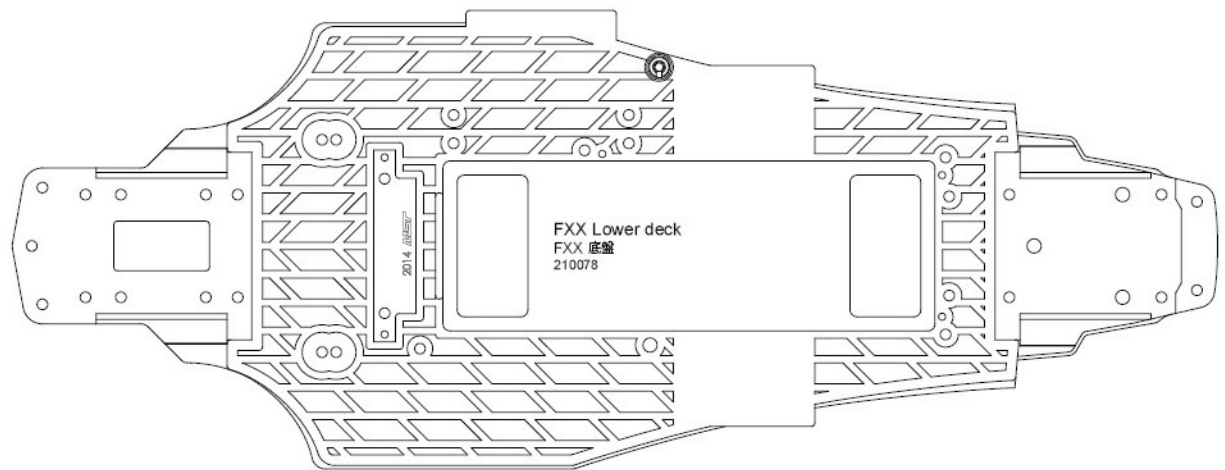

FXX Lower deck  
FXX 底盤  
210078

# FXX-D RTR

1/10 SCALE RC RWD HIGH PERFORMANCE DRIFT CAR

## SETUP SHEET

ORIGINAL SETTING

DATE: \_\_\_\_\_

SURFACE: \_\_\_\_\_

NOTE: \_\_\_\_\_

TRACK: \_\_\_\_\_

GRIP: \_\_\_\_\_

**Caster**

8°  
 12°  
 16°

**Front wheel hubs**

0 mm

**Battery position options**

**Rear wheel hubs**

0 mm

**FRONT** **REAR**

Tire: \_\_\_\_\_  
 \_\_\_\_\_  
 Wheel: \_\_\_\_\_  
 \_\_\_\_\_  
 Offset: \_\_\_\_\_

**Front damper stay**

4 3 2 1

Camber: 4°  
 Toe-in: 1°

Ride height: 45 mm

GROUND

**Front rollcenter**

0 mm

0 mm

**Front lower arm**

1 2 3 4 5 6

**Front damper**

Length

Shock oil: #150 Spring color: silver  
 Length: 63 mm Piston: Ø1.2 mm  
 Spring: 29 mm Ø1.4 Piston hole: 3

**Front upright**

0 mm

0 mm

0 mm

**Rear upright**

**Rear damper stay**

4 3 2 1

mm

Camber: 5°  
 Toe-in: -3°

Ride height: 55 mm

GROUND

**Rear rollcenter**

0 mm

0 mm

0 mm

**Rear lower arm**

1 2 3 4 5

**Rear damper**

Length

Shock oil: #150 Spring color: Red  
 Length: 63 mm Piston: Ø1.2 mm  
 Spring: 29 mm Ø1.2 Piston hole: 3

**Suspension mount**

+0.5

+0.5

+2.5

-0.5

Diffuser

Balancing weight 30 g

+0 mm

-0 mm

0

Motor Position: 0 mm

**Rear diff**

Gear diff  
 Diff oil \_\_\_\_\_

Spool  
 Ball diff.

Alum spool

**Ballast:**

\_\_\_\_\_

\_\_\_\_\_

\_\_\_\_\_

\_\_\_\_\_

Gear A × Gear C × Big Bevel Gear ÷ Gear B ÷ Small Bevel Gear ÷ Pinion Gear = Gear ratio

28T × 36T × 36 T ÷ 20T ÷ 17 T ÷ T = \_\_\_\_\_

Motor & ESC: \_\_\_\_\_ Battery: \_\_\_\_\_

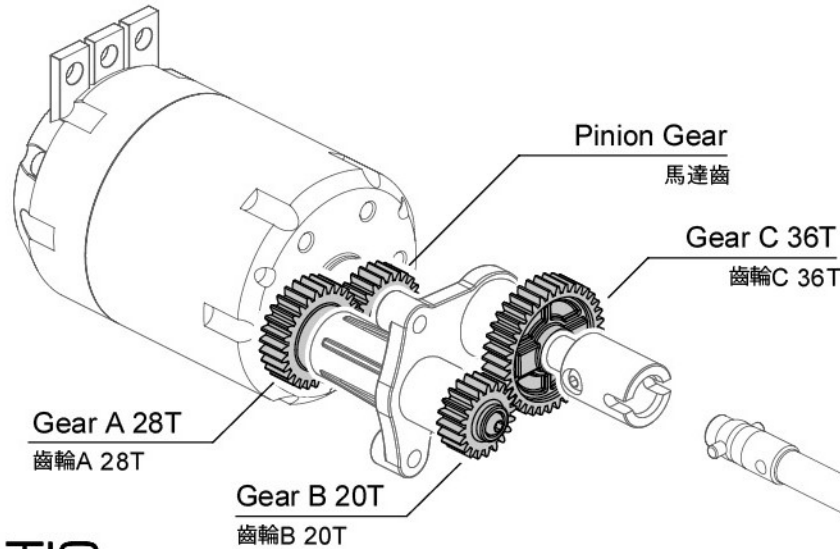

	1st Reduction Gear 1次減速齒	2nd Reduction Gear 2次減速齒	3rd Reduction Gear 3次減速齒
<b>PASSIVE GEAR</b> 被動齒	Gear A 齒輪A <b>28T</b>	Gear C 齒輪C <b>36T</b>	Big Bevel Gear 大傘齒 <b>36T</b>
<b>ACTIVE GEAR</b> 主動齒	Pinion Gear 馬達齒	Gear B 齒輪B <b>20T</b>	Small Bevel Gear 小傘齒 <b>17T</b>

※ Please set the gear ration according to motor specifications, environments, and personal requirements.  
齒比的選擇會因馬達規格、場地形態、車手手感，而有不同選擇。可先參考當地配置後再選擇齒輪比！

## GEAR RATIO 齒比表

For Gear A 28T				
	3rd Reduction rate. 3次減速比			
Pinion Gear 馬達齒	210362 32T/18T 1.78	210026 34T/18T 1.89	210034 36T/17T 2.12 Original setting	210025 40T/16T 2.50
18	4.98	5.29	5.93	7.00
19	4.72	5.01	5.62	6.63
20	4.48	4.76	5.34	6.30
21	4.27	4.53	5.08	6.00
22	4.07	4.33	4.85	5.73
23	3.90	4.14	4.64	5.48

For Gear A 30T (210402)				
	3rd Reduction rate. 3次減速比			
Pinion Gear 馬達齒	210362 32T/18T 1.78	210026 34T/18T 1.89	210034 36T/17T 2.12 Original setting	210025 40T/16T 2.50
16	6.00	6.37	7.15	8.44
17	5.64	6.00	6.73	7.94
18	5.33	5.67	6.35	7.50
19	5.05	5.37	6.02	7.11
20	4.80	5.10	5.72	6.75
21	4.57	4.86	5.45	6.43

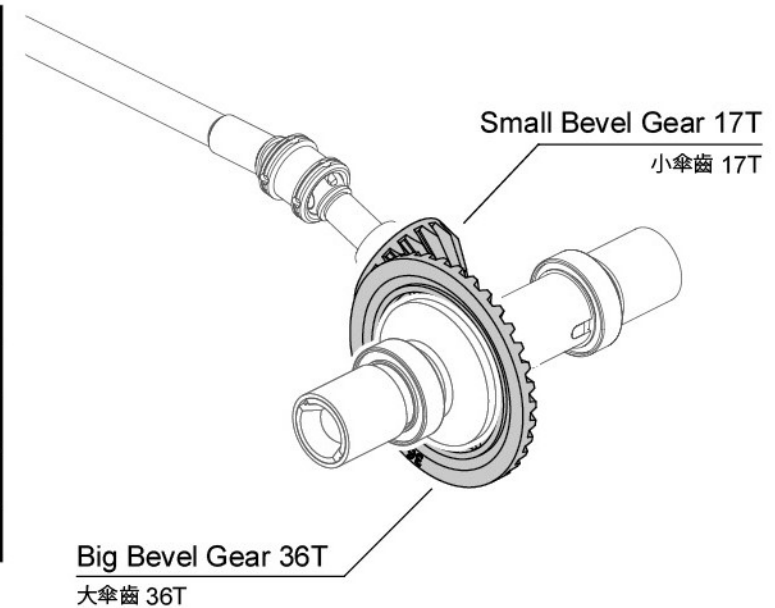

### ※ FORMULA 終傳比計算式

$$\text{Gear A} \times \text{Gear C} \times \text{Big Bevel Gear} \div \text{Gear B} \div \text{Small Bevel Gear} \div \text{Pinion Gear} = \text{Transmission ratio}$$

$$\text{齒輪A} \times \text{齒輪C} \times \text{大傘齒} \div \text{齒輪B} \div \text{小傘齒} \div \text{馬達齒} = \text{終傳比}$$

## PARTS CODE

101024	CS-R tire (soft) (4)	110048	Spacer 3×8×0.5 (8)	130004	Oil seal (4)	210063W	Shaft bush & spacer set (white)	310008	Piston rod (4)
101025	CS-R tire (medium) (4)	110049	Round head screw M3×5 (10)	130005	Bumper (A)	210071	Damper cylinder (2)	310046	Arm shaft 2.5×20 (2)
110001	Round head screw M3×6 (10)	110050	Round head screw M2×5 (6)	130006	Double sided tape (5)	210072	FXX Steering arm set	310047	Arm shaft 2.0×22 (2)
110002	Round head screw M3×8 (10)	110051	Flat head screw M3×5 (5)	130007	Antenna pipe(2)	210073	FXX Steering tumbuckle set	310048	Arm shaft 2.5×46 (4)
110003	Round head screw M2.5×6 (6)	110052	Countersunk screw M3×10 (10)	130017	Inner sponge (8)	210075	FXX Motor mount set	310049	2WD Axle (2)
110004	Round head screw M2×4 (6)	110053	Cap screw M2.5×30 (2)	130023	O-ring P3 (black) (10)	210076	FXX Reducer set	310051	CVA Swing shaft 44 (2)
110005	Countersunk screw M3×8 (10)	110059	Shaft 1.5×7.8 (8)	130032	Damper cap O-ring (10)	210077	FXX Rear gear box set	310052	FXX Drive gear shaft
110008	Set screw M3×25 (6)	110061	Round head screw M3×14 (6)	130034	Sponge 20×80×1 (4)	210078	FXX Lower deck	310053R	Spring retainer (red) (2)
110011	Cap screw M3×6 (6)	110063	Round head screw M2×8 (6)	130035	L Wrench set (1.5 & 2.0 & 2.5)	210079	FXX Upper deck	310054	Copper ball connector 4.8×4.5 (4)
110012	Flat head screw M3×11 (10)	110067	Set screw M2.5×2.5 (6)	130036	Tools	210080	FXX Reduction gear set	310055	Copper hex ball 4.8 (4)
110013	E-clip 2.0 (10)	110069	G-clip 9.0 (10)	210002	C PARTS-bumper set	210082	Piston spacer set	310056	FXX Steering arm post
110015	Flange nut M4 (4)	110070	E-clip 3.0 (10)	210003	D PARTS-ball connector	210083	Lower arm mount -0.5	600002	XTR-02 2.4G Transceiver set
110017	Shaft 2×9.8 (10)	110074	Tapping round head screw 3×8 (10)	210031	Reinforced adjuster set 5.8×26	210084	Lower arm mount +0.5	601003	RTR Servo
110019	Shaft 2×11.8 (5)	110075	Tapping flat head screw 3×7 (10)	210032	Servo horn set (23T/ 25T)	210086	Lower arm mount +2.5	601011	XBLS sensored brushless ESC 60A
110022	Tapping round head screw 3×6 (6)	110076	Round head screw M3×25 (6)	210034	Bevel gear set 36-17	210145CR	Brake calipers (red) (4)	601012	XBLS sensored brushless motor 21.5T
110025	Tapping round head screw 2.6×10 (6)	110082	Round head screw M2×3 (6)	210040	Joint set	210273-1	Coil spring 29mm (hard) (silver) (2)	820015	Spacer 4×6×0.1 (8)
110026	Round head screw M3×10 (10)	120001	Ball bearing 10×15 (4)	210043	Wheel hubs w/disc shape	210335R	FXX Alum. rear drive shaft set (red)	820017	Spacer 4×6×0.3 (8)
110029	Round head screw M3×12 (6)	120002	Ball bearing 5×10 (4)	210054	HT Lower arm	210344	Ball connector nut L 4.8 (4)	820022	Spacer 10×12×0.1 (8)
110035	Set screw M3×3 (6)	120007	Ball bearing 8×14 (2)	210055	HT Rear lower arm & wheel hub	210347	FXX Drive gear shaft	820024	Spacer 10×12×0.3 (8)
110038	Flat head screw M3×7 (10)	120011	Ball bearing 5×11 (4)	210056	Spool parts set	210351-3	Soft coil spring 29mm (soft) (red) (2)	820079	Damper plastic maintenance set (2)
110041	Countersunk screw M3×5 (10)	120013	Ball bearing 4×8×3 (2)	210057	Damper cap set	230011SG	Silver grey 5H wheel (+1) (4)	820088	MST Balancing weights 30g (4)
110044	Round head screw M2×6 (6)	120014	Ball bearing 6×10×3 (2)	210058	HT Upper arm	230012SG	Silver grey TE wheel (+1) (4)	841003	LSD 2.0 S Gyro
110046	Shaft 2×9.8 (8)	120017	Bearing 5×8 (4)	210059	FXX Battery guard set	230013	FXX FSX F&R damper stay	148013~	MST 48P Pinion gear 13T~35T
110047	Spacer 3×6×0.5 (8)	130001	Damper O-ring P3 (red) (10)	210060	KPI Upright set	310006	Wheel axle (2)	148035	

## 部品編號

101024	CS-R尾尾胎 (軟) (4)	110048	墊片 3×8×0.5 (8)	130004	避震氣室 (4)	210063W	襯套墊片組 (白)	310008	避震軸心 (4)
101025	CS-R尾尾胎 (中) (4)	110049	六角半圓頭螺絲 M3×5 (10)	130005	防撞泡棉 (A)	210071	避震器筒身 (2)	310046	擺臂插銷 2.5×20 (2)
110001	六角半圓頭螺絲 M3×6 (10)	110050	六角半圓頭螺絲 M2×5 (6)	130006	泡棉雙面膠 (5)	210072	FXX 轉向搖臂組	310047	擺臂插銷 2.0×22 (2)
110002	六角半圓頭螺絲 M3×8 (10)	110051	十字扁頭螺絲 M3×5 (5)	130007	天線管 (2)	210073	FXX 轉向拉桿組	310048	擺臂插銷 2.5×46 (4)
110003	六角半圓頭螺絲 M2.5×6 (6)	110052	六角沉頭螺絲 M3×10 (10)	130017	吸震泡棉 (8)	210075	FXX 馬達座組	310049	二驅輪軸 (2)
110004	六角半圓頭螺絲 M2×4 (6)	110053	六角有頭螺絲 M2.5×30 (半牙) (2)	130023	O環 P3 (黑) (10)	210076	FXX 減速箱組	310051	CVA傳動軸 44 (2)
110005	六角沉頭螺絲 M3×8 (10)	110059	插銷 1.5×7.8 (8)	130032	避震上蓋O環 (10)	210077	FXX 後齒箱組	310052	FXX 驅動齒軸
110008	六角止付螺絲 M3×25 (6)	110061	六角半圓頭螺絲 M3×14 (6)	130034	吸震泡棉 20×80×1 (4)	210078	FXX 底座	310053R	避震器調整環 (紅) (2)
110011	六角有頭螺絲 M3×6 (半牙) (6)	110063	六角半圓頭螺絲 M2×8 (6)	130035	L 板手組 (1.5 & 2.0 & 2.5)	210079	FXX 二樓板	310054	銅製內六角球頭 4.8×4.5 (4)
110012	十字扁頭螺絲 M3×11 (10)	110067	六角止付螺絲 M2.5×2.5 (6)	130036	工具包	210080	FXX 減速齒組	310055	銅製外六角球頭 4.8 (4)
110013	E扣 2.0 (10)	110069	G扣 9.0 (10)	210002	C PARTS-防撞板組	210082	避震器活塞墊片組	310056	FXX 轉向搖臂支柱
110015	凸緣螺帽 M4 (4)	110070	E扣 3.0 (10)	210003	D PARTS	210083	下擺臂座 -0.5	600002	XTR-02 2.4G 遙控器組
110017	插銷 2×9.8 (10)	110074	自攻六角半圓頭螺絲 3×8 (10)	210031	強化拉桿頭組 5.8×26	210084	下擺臂座 +0.5	601003	RTR 伺服機
110019	插銷 2×11.8 (5)	110075	自攻六角沉頭螺絲 3×7 (10)	210032	伺服機舵片組 (23T/ 25T)	210086	下擺臂座 +2.5	601011	XBLS 有感無刷電變 60A
110022	自攻六角半圓頭螺絲 M3×6 (6)	110076	六角半圓頭螺絲 M3×25 (6)	210034	傘齒組 36-17	210145CR	煞車卡鉗 (紅) (4)	601012	XBLS 有感無刷馬達 21.5T
110025	自攻六角半圓頭螺絲 2.6×10 (6)	110082	六角半圓頭螺絲 M2×3 (6)	210040	接杯組	210273-1	避震彈簧 29mm (硬) (銀) (2)	820015	墊片 4×6×0.1 (8)
110026	六角半圓頭螺絲 M3×10 (10)	120001	培林 10×15 (4)	210043	碟型六角輪座組	210335R	FXX 鋁合金雙節後軸組 (紅)	820017	墊片 4×6×0.3 (8)
110029	六角半圓頭螺絲 M3×12 (6)	120002	培林 5×10 (4)	210054	HT 下擺臂	210344	球頭螺帽 L 4.8 (4)	820022	墊片 10×12×0.1 (8)
110035	六角止付螺絲 M3×3 (6)	120007	培林 8×14 (2)	210055	HT 後下擺臂 & 輪座	210347	FXX 傳動齒輪軸	820024	墊片 10×12×0.3 (8)
110038	十字扁頭螺絲 M3×7 (10)	120011	培林 5×11 (4)	210056	塑膠直軸配件組	210351-3	軟避震彈簧 29mm (軟) (紅) (2)	820079	避震膠件包 (2)
110041	六角沉頭螺絲 M3×5 (10)	120013	培林 4×8×3 (2)	210057	避震器上下蓋組	230011SG	銀灰5H輪框 (+1) (4)	820088	MST 配重塊 30g (4)
110044	六角半圓頭螺絲 M2×6 (6)	120014	培林 6×10×3 (2)	210058	HT 上擺臂	230012SG	銀灰TE輪框 (+1) (4)	841003	LSD 2.0 S 陀螺儀
110046	插銷 2×9.8 (剖溝) (8)	120017	軸承 5×8 (4)	210059	FXX電池擋板配件組	230013	FXX FSX 前後避震架	148013~	MST 48P 馬達齒 13T~35T
110047	墊片 3×6×0.5 (8)	130001	阻尼器O環 P3 (紅) (10)	210060	KPI 輪座組	310006	萬向接杯 (2)	148035	

026105